



VIVAK®

S H E E T



SAN DIEGO PLASTICS, INC.

2220 MCKINLEY AVENUE, NATIONAL CITY, CA 91950

619/477-4855 FAX 477-4874

www.sdplastics.com



Fabricating, Forming, Finishing Guide

Sheffield Plastics Inc.

A  Bayer MaterialScience Company

VIVAK® SHEET: PROVIDING OPTIONS THAT WORK FOR YOU



VIVAK Sheet offers you the kind of fabricating, forming, and finishing ease that can really make a difference on the job. It delivers impact strength that acrylic just can't touch. At the same time, VIVAK Sheet provides many of the advantages of polycarbonate, but without the high material costs.

Higher performance compared to acrylic translates into thinner gauges and higher rates of production through easy die cutting, punching, and low-temperature forming. VIVAK Sheet's forgiving nature also means less breakage during production, which can mean higher margins and lower costs.

VIVAK Sheet offers deep draws, complex die cuts, and precise molded-in details without sacrificing structural integrity. It can be bonded or fastened with adhesives, tapes, ultrasonic welding or rivets. VIVAK Sheet allows you to fabricate large, complex shapes cost effectively compared to both polycarbonate and acrylic. Combine all these advantages with the choice of a full palette of custom colors and a complete array of finishing options, and you'll see why VIVAK Sheet is the answer.

Features and Benefits:

- Complex Die Cutting
- Down Gauging
- Riveting
- Punching
- Superior Impact Strength
- Design Flexibility
- Cold Forming

Contents

	Page		Page
Fabricating		<i>Thermoforming continued</i>	
Sawing	3	Free Blown Billow Forming of Dome	9
Routing	3	Free Drawn Vacuum Dome Forming	9
Shearing, Blanking, Punching	4	Drape and Cylindrical Forming	9
Laser Cutting	4	Registration Forming	9
Die Cutting	4		
Drilling	5	Bonding/Fastening	
Milling	5	Solvent Bonding	10
		Transfer Tape Bonding	10
Forming		Mechanical Fastening	10
Brake Forming and Cold Bending	6	Welding	10
Strip Heating	6		
Thermoforming	7	Finishing	
Forming Equipment	7	Sanding	11
Heaters	7	Jointing-Planing	11
Molds	7	Flame Polishing	11
Mold Design	7	Solvent Polishing	11
Heating Cycle	8	Hot Stamping	11
Shading or Screening	8	Screen Printing	11

Sawing

A circular blade with carbide-tipped teeth utilizing the "triple-chip" tooth design is the preferred method of cutting VIVAK® Sheet. Table or overhead saws can be used successfully.

Circular Saws

Circular saws should be run at relatively high speeds in the range of 8,000-12,000 linear feet per minute. Blades should have 3-5 teeth per inch. As a general rule, thicker gauge sheet requires fewer teeth per inch. A circular saw is preferable to a band saw for straight cuts, because a smoother cut can be achieved. When sawing thin gauge sheet, it is important to have a good supporting edge on the saw table with minimal gap between the saw blade and table edge. When stack cutting, it is a good idea to clamp the top surface to prevent vibration. Be sure tabletops are smooth and free of projections that might scratch or mar the VIVAK.

Band Saws

Band saws are useful for trimming formed parts or irregular shapes. Band saws should be run at 2,000 feet per minute and have between 3-15 teeth per inch. Coarser (larger tooth) blades perform better with thicker gauge plastic. Because vibration can induce cracking of VIVAK Sheet, proper support of the part to be trimmed is important. If the cut edge is not smooth, cracks will propagate from erose or notched edges.

Note: Always use proper eye protection when sawing

Sawing Recommendations

Type of Cut	Tool	Blade Type	Blade Parameters	Blade Speed
Straight Cut	Circular Saw	Triple-chip Design	7-1/4" diameter, 40 teeth (carbide-tipped cutoff) 7-1/4" diameter, 200 teeth plywood blade	4,500 rpm
Curved Cut	Saber or Jigsaw	Finish Cutting Blade	7 teeth per inch	
Curved Cut	Band saw	1/2"	3 teeth per inch	2,000 ft/min
Trimming & Deflanging	Router	Carbide-tipped or High-speed Steel, Double Fluted	3/8" diameter	20,000 rpm

Routing

Routing produces a smooth edge on VIVAK Sheet and can be employed to cut curved or irregular shapes. Routers with a speed of 20,000 to 25,000 rpm are preferred. Use straight fluted carbide-tipped router bits. High-speed steel bits may also be used. Bits should be 3/8" to 1/2" diameter for best results. Portable routers, over-arm routers, or under-the-table routers are all useful. Use a router with at least a 1 h.p. motor.

Special care must be used when routing. Use proper guarding and eye protection. Stock feed rates need to be monitored. Feeding VIVAK Sheet, at fast rates can result in shattering. It is important to feed the sheet against the rotation of the router bit and to provide a fence for sizing. Router bits must be kept sharp. Cooling the bit with compressed air during operation will aid chip removal and prolong sharpness.

Circular Saw Troubleshooting

Problem: Melting or Gummed Edges

Suggested Solutions:

1. Increase blade tooth size
2. Reduce saw speed
3. Provide better clamping and/or support for material
4. Use air to cool blade
5. Reduce feed rate
6. Inspect blade for sharpness

Problem: Chipping

Suggested Solutions:

1. Decrease blade tooth size
2. Increase saw speed
3. Increase feed rate
4. Inspect blade for sharpness
5. Check blade and arbor for wobble
6. Check blade fence alignment

Band Saw Troubleshooting

Problem: Melting or Gummed Edges

Suggested Solutions:

1. Increase tooth size
2. Reduce saw speed
3. Use air to cool blade
4. Check blade sharpness

Problem: Chipping

Suggested Solutions:

1. Decrease tooth size
2. Slow down stock feed rate
3. Provide better clamping and/or support to eliminate vibration
4. Check blade sharpness

Die Cutting Equipment Suppliers:
National Steel Rule Die Co.
3580 Lightner Rd.
Vandalia, OH 45377
Tel: (937) 667-8407

Atlas Die Inc.
2000 Middlebury Street
Elkhart, IN 46516
Tel: (574) 295-0050

Saw Blade Suppliers:
Dino Saw, Inc.
340 Power Avenue
Hudson, NY 12534
Tel: (518) 828-9942

Forrest Mfg.
457 River Road
Clifton, NJ 07014
Tel: (973) 473-5236

Shearing, Blanking, Punching

Other suitable methods for cutting VIVAK® Sheet include: shearing, blanking, and punching. Shears produce straight-edged cuts, while blanking dies and punches can produce a wide variety of shapes.

VIVAK Sheet in thicknesses up to .100" gauge may be sheared using conventional sheet metal power shears. It is important to adjust the blade clearance in relationship to the bed knife. A clearance of .001" is desirable to avoid a rough edge cut. Material thicker than .100" gauge should be saw cut. Stack shearing of VIVAK Sheet is not recommended.

Blanking and punching may be utilized for VIVAK Sheet gauges up to .100". Other fabrication techniques such as sawing, drilling, and routing should be used for thicker gauges.

Laser Cutting

Laser beams can be used to cut VIVAK sheet in thicknesses up to .187". Laser power and travel speed must be optimized in order to minimize whitening while cutting VIVAK Sheet.

Die Cutting

VIVAK Sheet in gauges up to .100" can be die cut using steel rule or matched metal dies. Steel rule dies are the most common type and double bevel blades provide adequate edges for most applications. If improved edge finish is required, try the flush type of blade. Under normal conditions, 3 point (.042") thick blades work well. Keep the backup pad in good shape. It is important to have parallel alignment of the die and platen.

Adequate power in the die press is needed to achieve the desired cut. Calculate the required tonnage by the formula:

$$F = \frac{PA}{2,000 \text{ lb.}}$$

F = Tonnage of press

P = 9,000 psi
(VIVAK Sheet shear strength)

A = Cross-sectional area

Cross-sectional area is determined by the perimeter of the object to be cut times the thickness of blade penetration.

Die Design

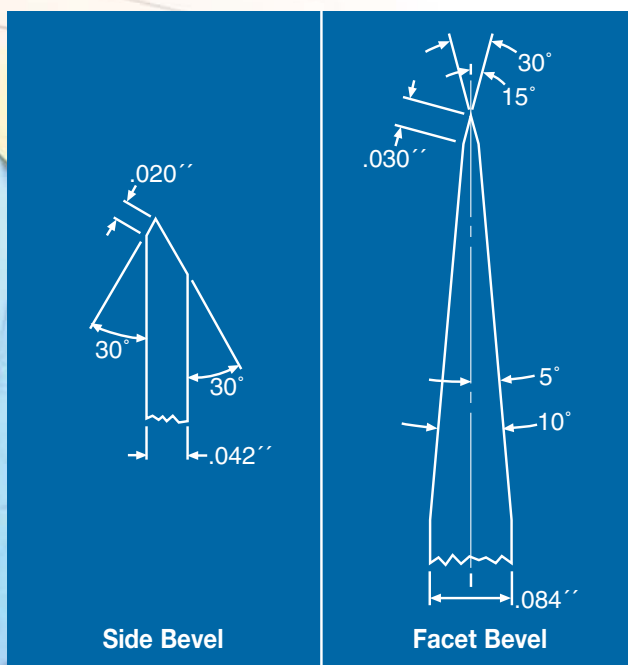

Laser Supplier:
Convergent Prima
Picker Road
Sturbridge, MA 01566
Tel: (508) 347-2681

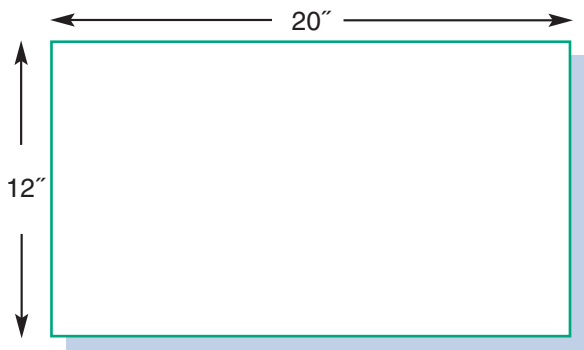

Example:

A 12" x 20" x .030" rectangle
 $12 + 12 + 20 + 20 = 64" \times .015^*$
 *.015 represents the width of blade at full penetration.

$$64 \times .015 = .96 = A$$

$$F = \frac{9,000 (.96)}{2,000} = 4.32 \text{ ton press}$$

required force

Drilling

Drills specifically designed for plastics are recommended. Standard twist drills for metal or wood can also be useful.

VIVAK® Sheet is easily drilled using zero-degree rake angle bits with dubbed off cutting edges. Regulate pressure and speed until a continuous spiraling chip is observed. Back out drill regularly to free chips. This is particularly important when drilling deep holes. Typically, peripheral speeds of twist drills for plastics range from 100 to 200 feet per minute. The rate of drill feed into the VIVAK Sheet can vary from 0.010 to 0.025 inch per revolution.

Use air or water as a coolant, if required. Do not use cutting oils. Do not drill and tap or use self-tapping screws. Like most other transparent plastics, VIVAK Sheet is a notch-sensitive material and the cutting threads develop stress points that can create stress crazing or cracking.

Be sure drilled holes are smooth with no evidence of cracks or roughness, which can cause weak areas in fastening. Always hold or clamp securely to prevent cracking or slipping and to ensure operator safety.

Milling

VIVAK Sheet can be machined with standard high-speed milling cutters for metal, provided the cutters have sharp edges and adequate clearance at the heel. Favorable results can be achieved using a 5/8" diameter bit at 500 rpm with a travel of 5 inches per minute.





FORMING

Brake Forming and Cold Bending

Brake forming and cold bending operations can be used to make simple bends and curved areas with VIVAK® Sheet.

Brake forming can be done on standard sheet metal brakes. Do not attempt to bend gauges over .080", because stress levels are too high and failure can occur.

VIVAK Sheet may be cold formed into circular shapes by observing the rule that the radius of curvature must be at least 100 times the material thickness. Example: .080" gauge = 8" radius (16" diameter circle).

Strip Heating

Because of its low thermoforming temperature, VIVAK Sheet is easy to strip heat and line bend.

Using a device similar to the illustration shown, regulate the heat to a temperature that allows VIVAK to reach 280°F. Thicker gauge VIVAK Sheet requires a longer period of time to allow heat penetration.

Procedure

- Remove protective masking from area to be bent
- Regulate heat source to allow VIVAK Sheet to reach 280°F-320°F
- Place sheet over heat source at bend area
- Allow heat to soften material; time depends on gauge, 1/8" normally requires 2 minutes
- Remove sheet and make desired bend, and place in wood or fabric-covered aluminum fixture
- Allow bent part to cool in fixture

Strip Heating Troubleshooting

Problem: Bubbles in bent area

Possible Cause: Too much heat

Suggested Solution:

1. Reduce temperature

Problem: Warpage

Possible Cause: Part too wide for strip heating. Heating not uniform.

Suggested Solution:

1. Check for drafts
2. Check heat source for uniformity

Possible Cause: Cooling not uniform

Suggested Solution:

1. Check for drafts
2. Cooling fixtures may be removing too much heat in an area

Problem: Mark off

Possible Cause: Heater is contacting plastic

Suggested Solution:

1. Increase gap between heater and sheet

Possible Cause: Transite is too hot

Suggested Solution:

1. Increase width of slot in transite

Possible Cause: Masking not removed in wide enough area

Suggested Solution:

1. Remove masking further away from heated area

Helpful Hints

- Try to reproduce the suggested steps accurately from part to part
- Avoid drafty rooms which can cause uneven heating and cooling
- Be sure to cover forming fixtures with soft fabric to avoid scratching VIVAK Sheet
- Overheating can cause bubbles along bend area
- Bending VIVAK Sheet when it is too cold results in a highly-stressed, weakened part
- Thicker gauges (over .125) may require heating on both sides by turning the sheet over periodically during the heating cycle. Always bend the sheet with heated side forming the outside radius.

Heat Bending Device

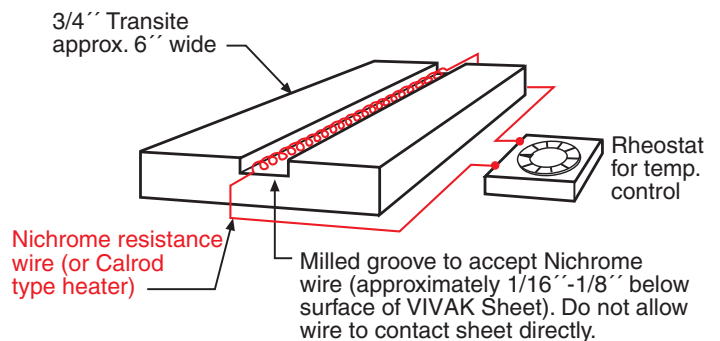

Thermoforming

VIVAK® Sheet offers deeper draws without the webbing often associated with acrylic. It can be thermoformed on standard equipment. The most extensively used processes are vacuum forming, free blown forming, and line bending.

Forming Equipment

The thermoforming machine should be capable of generating and maintaining sufficient vacuum pressure throughout the thermoforming cycle. A minimum of 20 in. Hg. throughout the entire vacuum cycle is required to retain part integrity.

Most commonly used vacuum forming machines with infrared heating elements perform well for VIVAK Sheet forming. Rotary and shuttle designs with automatic or semiautomatic controls are most suitable. Key features of this type of equipment include: timer control accuracy, uniform heating sources, and sufficient vacuum power. Single-sided heating has proven effective for VIVAK Sheet in gauges up to .177". For thicknesses above .177", dual-sided heating ovens can be used for faster radiation penetration and quicker cycle times.

Heaters

Infrared cal rod, coiled nichrome, or ceramic heating elements provide the best heating sources. Uniform heating of the sheet is critical. Radiation absorption graphs for VIVAK Sheet are available. Matching the emissivity of the heating elements provides the most efficient heat penetration.

Typical Mold Materials Thermal Conductivity Properties

Material	Heat Transfer Rate Factor	K Value BTU/HR/SF/F/FT
Aluminum	6190	130
Steel	1238	26
Aluminum filled epoxy	24-47	.52-.87
Plaster of paris	8.29	.17
Epoxy	6.24	.13
Wood (maple)	4.48	.09

Mold Shrinkage

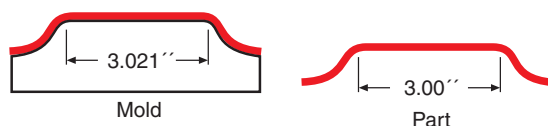

Mold Materials and Mold Design

VIVAK Sheet allows the use of a wide variety of mold materials including: wood, filled and unfilled polyesters, epoxies, and metals.

Molds for vacuum forming need to take only 14 psi, so there is little wear on the tooling with low pressure of the material against the mold surface.

Use standard mold design practices and mold materials.

Molds

Although male molds are more suitable for vacuum forming in general, other factors such as part size, finish, and shape must be considered in mold design. Choice of mold materials should be determined by considering the length of the production run. For optimum cost-effectiveness, use the least expensive material that will take the entire run.

It is evident that thermal transfer is much more efficient with aluminum than wood. Wood, however, can be utilized for short-run projects.

VIVAK Sheet tends to reproduce mold surface finish quite faithfully, even to the point of replicating wood grain in a smooth wood mold.

Sometimes it is desirable to reduce the polish on a steel or aluminum mold by utilizing a vapor hone or bead blast. This is due to the fact that if the mold surface is too smooth, air entrapment can occur creating "mark off". For best results, use fine hand sanding on the surfaces. Sanding provides tiny channels for air evacuation to prevent air entrapment. This may have to be repeated on long production runs, as the sanded finish smooths out from extended use.

When constructing the mold, mold shrinkage should be a design consideration. Shrinkage for VIVAK Sheet is .005"-.007"/in. The heating/cooling cycle and the type of vacuum forming equipment will also influence results.

Mold Design

Draft Angles: Minimum 5°-7° or greater for ease of part removal from the mold.

Radii and Fillets: Use generous radii wherever possible for more uniform walls and greater rigidity. On female tooling, use permanent corner fillets.

Vacuum Holes: In order to form the sheet as rapidly as possible, use sufficient holes for fast evacuation of air from between the sheet and the mold. In female molds, use air evacuation holes at all deep draw areas, especially around the mold perimeter where the sheet will be drawn last.

Helpful Hints

- Keep the diameter of the holes small (approximately 1/64"-1/32" diameter) to avoid marking on the sheet. Long, thin slots may be designed for air evacuation in female tooling.
- Use vapor honed or fine sanded finishes
- Avoid sharp corners to minimize stress
- Avoid highly polished surfaces that can cause mark off
- If mold temperature becomes too high during thermoforming runs, VIVAK Sheet could stick to the mold. It is recommended that the mold temperature not exceed 140°F.

Strip Heating Suppliers:

FTM Plastic Welding, Inc.
6160 Cobblestone Road
Placerville, CA 95667
Tel: (530) 626-1986

Craftics, Inc.
PO Box 91930
Albuquerque, NM 87199
Tel: (505) 338-0005

MOLD DESIGN CONTINUED

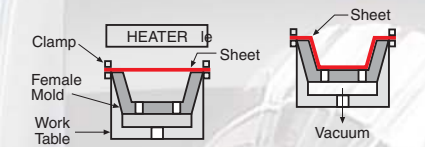

Straight vacuum forming in a female mold is recommended for low-profile parts where deep draw is not a requirement.

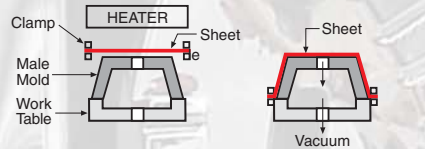

Drape forming over a male mold usually results in better material distribution and depth-to-diameter draw ratios.

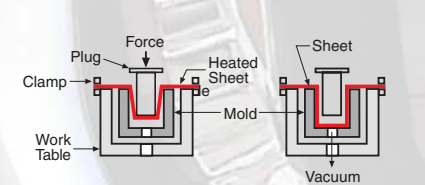

Thinning of material in deep-mold cavities can be overcome by use of plug assists designed for fast penetration.

Forming Guidelines

Sheet Temperature:
 Typical: 280°F-320°F
 Mold Temperature: 130°F-140°F

Helpful Hint

- Throughout the vacuum forming process, it is imperative that dust and dirt be controlled. VIVAK Sheet has a static charge that attracts foreign particles which can create surface imperfections. Molds also attract dust particles and should be cleaned to avoid creating surface defects.

Thermoforming Troubleshooting

Problem	Possible Cause	Suggested Solution
Part weak or crazed	<ul style="list-style-type: none"> Forming temperature too low 	<ul style="list-style-type: none"> Increase heat setting
Webbing	<ul style="list-style-type: none"> Uneven Heat 	<ul style="list-style-type: none"> Check for hot spots in heaters Spacing between molds should be 2" x height
Part sticks to mold	<ul style="list-style-type: none"> Mold spacing too close in multiple mold Vacuum rate too fast Mold too hot Not enough draft angle Mold finish too smooth 	<ul style="list-style-type: none"> Restrict vacuum Reduce mold temp Increase draft Vapor hone or sand with light finish sand paper
Mark off		
Pinholes on surface	<ul style="list-style-type: none"> Dust on sheet or mold 	<ul style="list-style-type: none"> Blow off sheet and mold with air
Incomplete part detail	<ul style="list-style-type: none"> Insufficient vacuum Sheet too cold 	<ul style="list-style-type: none"> Check system for vacuum leaks; add vacuum holes
Bubbles in sheet	<ul style="list-style-type: none"> Excessive heat 	<ul style="list-style-type: none"> Increase heat setting
Non-uniform sag	<ul style="list-style-type: none"> Uneven heating 	<ul style="list-style-type: none"> Reduce heat setting Check heaters Screen "hot" areas
Sheet pulls out of clamping frame during forming	<ul style="list-style-type: none"> Sheet too cold to form 	<ul style="list-style-type: none"> Heat sheet for longer time period

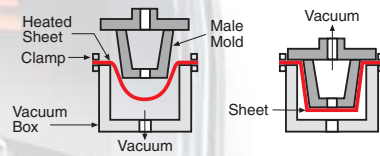

Vacuum forming with snap-back can reduce starting sheet size, aid material distribution, and minimize chill marks.

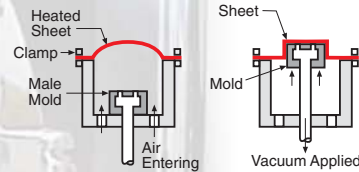

Air-slip forming is similar to vacuum snap-back except that heated sheet is billowed up and mold rises to meet it.

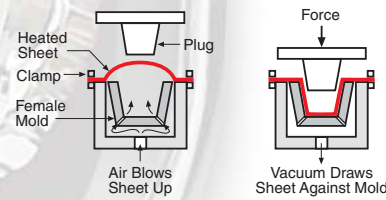

Forming with billow plug is often used to produce thin-wall items with depth-to-diameter draw ratios up to 1.5:1.

Heating Cycle

Heating VIVAK® Sheet for vacuum forming requires heat penetration to achieve a 280°F to 320°F range. When VIVAK Sheet reaches forming temperature, uniform "sag" occurs. The amount of sag depends on the size and thickness of the sheet. A 12" x 12" x .060" sheet will sag approximately 1". A 36" x 36" x .177" sheet may sag 4"-6" at the center. Once the uniform temperature has been achieved, timers can accurately reproduce the condition, and part-to-part consistency can be maintained.

Procedure

- Sheet thicknesses up to .177" gauge can be heated from one side. Above .177" gauge, two-sided heating is normally required to significantly enhance productivity.
- Heat source is removed and heated sheet is forced over or into mold where vacuum is applied.

Shading or Screening

Shading is often used to balance out hot spots in an oven for uniform temperature. Shading may also be used to control the sag of VIVAK Sheet during heating.

Procedure

- Use heavy-duty metal screening to shade the major portion of the clamped sheet, leaving several inches along the edges unshaded to compensate for cooler areas.
- Screens can be installed permanently or placed loosely above the Sheet, depending on how much shading is required.

Helpful Hints

- Use slow heating. This is particularly important with heavier gauges in order to prevent gradient heating.
- Allow heat to reach uniformity at the center of the sheet.
- The heating rate may be reduced by lowering the heat intensity or by moving the sheet farther away from the heaters.

Free Blown Billow Forming of Dome

This process is utilized for forming dome shapes from VIVAK® Sheet. The procedures and equipment are the same as vacuum forming with the exception of the mold. Billow forming can be done with positive air pressure (free blown) or negative pressure (vacuum).

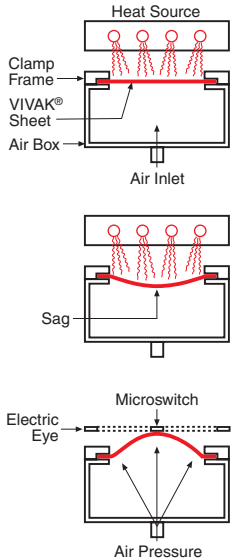

Procedure

- Place VIVAK Sheet in clamping frame of thermoforming machine
- Heat sheet until uniform sag occurs (280°F - 320°F)
- Remove heat source
- Lower pressure box to seal air supply pressure
- Apply air pressure. Initial air pressure is high, and as dome is created, air pressure is reduced.
- When overall height is achieved, maintain positive air pressure until part cools
- Be sure air source is properly filtered and uniformly dispersed for even formation of dome
- Utilize electric eye designs or microswitches to assure consistent product
- When dome reaches electric eye, set height. The eye controls air pressure through a solenoid valve to control cooling
- Remove and trim

Free Drawn Vacuum Dome Forming

Follow steps involved in vacuum thermoforming.

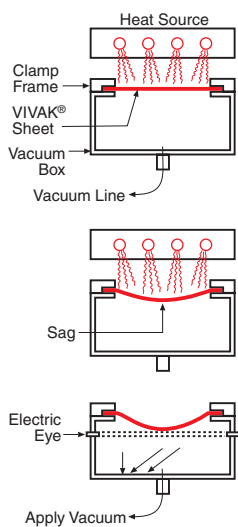

Procedure

- Place sheet in clamping frame of thermoforming machine
- Heat sheet until uniform sag occurs (280°F - 320°F)
- Remove heat source
- Apply vacuum seal box and apply vacuum pressure
- Use electric eye or microswitch to assure consistency of depth of dome
- Retain small amount of vacuum pressure until dome sets up
- Remove and trim

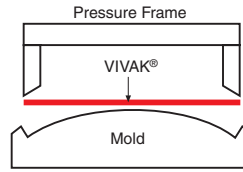

Drape Forming

Simple contours can be achieved by drape forming VIVAK® Sheet

Procedure

- This method can be utilized to manufacture a part requiring a simple radius of curvature. Mold material can be wood, fiberglass, or aluminum covered with felt.
- Bring to forming temperature of about 280°F-320°F in the oven
 - Remove parts and immediately place over a male mold covered with felt

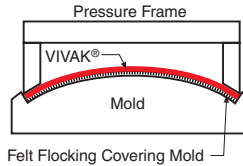

Cylindrical Forming

This method is useful for short run projects that are not cost-effective using drape-form molds, or where cold-forming is not applicable (i.e., frameless curved parts).

Procedure

- Position stops until the desired diameter is achieved
- Cold form VIVAK® Sheet into place between stop
- Heat the VIVAK Sheet in curved position for the normal cycle time
- Allow to cool, then remove from form

Note: Do not overheat. Closely monitor procedure for best results.

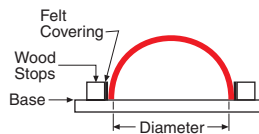

Registration Forming

VIVAK® Sheet is suitable for registration vacuum forming. Because the material is extruded, it is important to orient the sheet so that each part is screened and formed in the same direction each time. Material should be special ordered for this application. Shrink tests indicate VIVAK Sheet in free form shrinks about 5% in the direction of extrusion and 1% across the extrusion web.

Thermoforming Machine Suppliers:

Brown Machine
330 North Ross Street
Beaverton, MI 48612
Tel: (989) 435-7741

Plastic-Vac, Inc.
214 Dalton Avenue
Charlotte, NC 28206
Tel: (800) 438-4139

Solvent Bonding

Since VIVAK® has excellent chemical resistance, it is important to use proper solvent bonding techniques. Solvent bonding will reduce the impact performance of the bonded edge of most materials. When the highest possible impact performance is essential, use flexible adhesive bonding.

Many applications for VIVAK® Sheet involve fabrication of sheets to construct three-dimensional shapes. The most popular method is to solvent bond. VIVAK solvent bonding can be achieved using methods employed in fabricating other thermoplastics such as acrylic. The two most common methods are needle-type applicator capillary action and edge dipping. Both methods rely on smooth edge preparation, pressure, and curing.

Note: Use extreme caution when working with solvents. Adequate ventilation is essential. Control exposure levels according to OSHA guidelines. Obtain Material Safety Data Sheets from the solvent manufacturer.

Procedure

- Smaller items with flat surfaces can be bonded by placing the pieces together and applying the solvent along the edges using a needle applicator or hypodermic syringe. Make sure the solvent flows along the entire joint
- For bonding larger items, immerse the surfaces to be joined in the solvent until the material is softened
- Apply light pressure and hold until bond is set
- Avoid solvent pooling in the joint which can cause joint whitening and stress crazing

Helpful Hints

- Edges must be clean and free from dirt
- Light sanding of factory polished surfaces will aid in adhesion
- Surfaces should be smooth and properly aligned
- Recommended solvents are WELD-ON #3, WELD-ON #4, WELD-ON #7, (no edge bonds) and MC-Bond
- If joint whitening occurs, it may be caused by excessive moisture. Several techniques reduce whitening
- Fabricate in a climate-controlled area with low relative humidity
- The addition of 10% glacial acetic acid in the solvent reduces whitening
- Thickening the solvent with resin or sawdust promotes slower curing and reduces whitening
- Joint cure time is somewhat longer than acrylic. Be sure to retain fixture pressure until the joint is solid
- Success has been reported adhering small acrylic components to VIVAK Sheet using products such as MC-Bond and WELD-ON #55.

Adhesive Suppliers:

WELD-ON Cements:

IPS Corporation
17109 S. Main Street
Gardena, CA 90248
Tel: (800) 421-2677
(310) 898-3300

Supplier for mini-extruder welding equipment:

Columbine International, Ltd.
5441 Merchant Circle
Placerville, CA 95667
Tel: (800) 635-6693
columbineint.com

MC-BOND:

Polysciences, Inc.
400 Valley Rd.
Warrington, PA 18976
Tel: (800) 523-2575

Transfer Tape Suppliers:

3M/Industrial & Tape
Specialties Division
3M Center, Bldg. 220-7E-01
St. Paul, MN 55144-1000
Tel: (800) 362-3550

Saint-Gobain
1 Sealant Park
Granville, NY 12832
Tel: (518) 642-2200

Ultrasonic Welding Equipment:

Branson Ultrasonics Corp.
41 Eagle Road
Danbury, CT 06813
Tel: (203) 796-0400

Transfer Tape Bonding

Achieving a strong solvent bond using thin-gauge thermoplastics is extremely difficult due to the reduced size of the bond area.

However, structural bonding of thin-gauge VIVAK® Sheet can be accomplished by utilizing acrylic based transfer tapes along with slight design modifications.

Adhesive Bonding of VIVAK® LAP Shear Strength ¹ psi	Five-Minute Cure No Gap	One-Week Cure No Gap
Methyl ethyl ketone (MEK)	500	1,500
Cyclohexanone	0	1,100
Tetrahydrofuran (THF)	100	1,500
42% Methyl ethyl ketone (MEK)	400	1,900
42% Trichloroethylene		
16% Methylene chloride		
85% Methylene chloride	200	2,000
12% Trichloroethylene		
3% Methyl ethyl ketone (MEK)	NA	NA
MC-Bond	0	1,800
"WELD-ON" #3 Cement	400	2,100
"WELD-ON" #4 Cement		

¹For the purpose of this evaluation, all bonds were 1/2" x 1/4" lap-type bonds between sections of VIVAK tensile bars. Bonds were tested using standard tensile strength test apparatus and a cross-head speed of 2" per minute. All values are 3-test averages to the nearest 100 psi. Values less than 50 psi are listed as "0".

Procedure

- Bend a small return on the appropriate part to be fastened, approximately the width of the transfer tape
- Clean tape contact areas with 50/50 isopropyl alcohol-water mixture
- Apply transfer tape to the return
- Remove masking and press the part into place

Welding

While mechanical fastening and solvent bonding are the most often recommended methods for joining plastics, another alternative is welding. Ultrasonic spot welding has proven to be an appropriate method. Contact manufacturers of ultrasonic welding equipment for recommendations on section and joint design. Mini extruder welding can also be used to bond VIVAK sheet. Both methods can be used while maintaining FDA approval.

Mechanical Fastening

Self-closing rivets and machine screws may be used to join VIVAK Sheet parts, if proper consideration is given to the installation. Use oversized holes at least 1/64" larger than the fastener.



A cushion-type washer should be used to avoid localized stress on VIVAK Sheet. Use plastic or aluminum fasteners. Mechanical fastening will produce a stronger part than solvent bonded parts and allows for easier disassembly and cleaning.

Sanding

VIVAK® Sheet can be sanded using both wet and dry techniques. Gumming can result from dry sanding. Wet sanding produces a smooth finish. In both instances, the part will require further finishing in order to restore its high gloss.

VIVAK Sheet can also be buffed using a 2-wheel system. The first wheel uses a buffing compound to remove shallow scratches. The second buffing wheel is used for restoring the gloss.

Jointing-Planing

A standard woodworking jointer-planer is an excellent edge finishing machine for VIVAK Sheet. Blades must be carbide or high-speed steel. Avoid removal of too much stock on each pass. 1/64" or less stock removal normally yields the cleanest edge. Trying to remove too much material results in a rough edge or shattering of the sheet.

If smoother edges are required, wet sanding with fine grit sandpaper is recommended.

Flame Polishing

When flame polishing VIVAK Sheet use a standard butane or propane torch. Dress the edges by sanding or jointing to remove the deep tool or saw marks. After torch ignition, be sure to turn down oxygen levels to the lowest possible workable point while still maintaining flame. Pay close attention to controlling the distance between the sheet and the heat source. Without adequate control in these areas, surface whitening or excessive material flow may occur.

Note: As with acrylic, flame polishing VIVAK Sheet can cause long-term edge cracking. However, with continued practice and by using proper techniques, excellent results can be achieved in flame polishing VIVAK Sheet.

Solvent Polishing

In order to improve the look of saw-cut edges, begin by sanding the edges smooth. For smoother, glossy edges, consider solvent polishing with MEK or methylene dichloride. To prevent humidity blush after drying, it may be necessary to add a small amount of a slow-drying component such as diacetone alcohol or glacial acetic acid. Since VIVAK Sheet has such good chemical resistance properties, keep in mind that solvent polishing cannot be expected to totally eliminate sand marks from the sheet edge.

Note: Use extreme caution when working with solvents. Adequate ventilation is essential. Control exposure levels according to OSHA guidelines. Obtain Material Safety Data Sheets for the solvent manufacturer.

Hot Stamping

VIVAK Sheet is easily decorated by hot stamping. Normal operating conditions are: head (die) temperatures 375°F with 60 psi pressure, with dwell time 2-3 seconds.

Contact foil manufacturer for recommended application guidelines.

Hot Stamping Foil Suppliers:

ITW
5 Malcolm Hoyt Dr.
Newburyport, MA 01950
Tel: (978) 462-7300

Crown Roll Leaf, Inc.
91 Illinois Ave.
Patterson, NJ 07503
Tel: (800) 631-3831

Screen Printing

VIVAK Sheet can be printed with conventional printing equipment. Since the ink does not penetrate plastic, special printing inks are necessary. Abrasion can be minimized by applying a light coat of clear lacquer over the printing. Consider each application individually to decide on the best ink for the specific job. Consult with ink manufacturers for best results.

Procedure

- VIVAK Sheet provides an excellent medium for signs, when using standard silk screening equipment with screens of varying mesh (8x to 16x) regulating the amount of ink coverage
- Be careful not to exceed the heat distortion temperature of 164°F during the cure process
- As with all thermoplastics, it is very important to be sure the sheet is clean and free from dust and dirt prior to screening. Use ionized air to clean dust or pre-rinse with alcohol and a soft, nonabrasive cloth



Helpful Hints

- After screening, separate sheets on a drying rack until ink is fully cured
- Do not pack sheets for shipment until inks are dry
- VIVAK Sheet is not compatible with UV cure screen printing. Ultraviolet curing lamps tend to attack VIVAK Sheet, and some loss in physical properties occurs.

Paint Suppliers:

Spraylat Corporation
716 South Columbus Ave.
Mt. Vernon, NY 10550
Tel: (914) 699-3030

Red Spot Paint & Varnish Co.
1107 E. Louisiana St.
Evansville, IN 47711
Tel: (812) 428-9100

AKZO-Nobel
5555 Spalding Drive
Norcross, GA 30092
Tel: (800) 233-2303

Rohm and Haas
2700 East 170th Street
Lansing, IL 60438
Tel: (708) 474-7000

Screen Print Suppliers:

Nor-Cote International, Inc.
506 Lafayette Ave.
Crawfordsville, IN 47933
Tel: (800) 488-9180

Kolorcure
1180 Lyon Road
Batavia, IL 60510
Tel: (630) 879-9050

Coates Screen Inc.
180 East Union Avenue
East Rutherford, NJ 07073
Tel: (201) 933-6100

NazDar
8501 Hedge Lane Terrace
Shawnee, KS 66227
Tel: (800) 767-9942

PERFORMANCE

VIVAK® Sheet combines an excellent balance of properties for a wide range of fabricated products.

TYPICAL PHYSICAL PROPERTIES OF VIVAK SHEET

Property	VIVAK® Sheet	Units	Test Method
General			
Specific Gravity	1.27	-	ASTM D-792
Water Absorption after 24 hrs.	0.2	%	ASTM D-570
Thermal			
Deflection Temperature @ 264 psi	157	°F	ASTM D-648
Deflection Temperature @ 66 psi	164	°F	ASTM D-648
Coefficient of Thermal Expansion	3.8	in/in/°F x 10 ⁻⁶	ASTM D-696
Flammability ≥ .060"	HB	-	UL 94
Glass Transition Temperature	178	°F	-
Forming Temperature	280°-320°	°F	-
Mechanical			
Tensile Strength, Ultimate .125"	7,700	psi	ASTM D-638
Tensile Modulus .125"	320,000	psi	ASTM D-638
Flexural Strength .125"	11,200	psi	ASTM D-790
Flexural Modulus .125"	310,000	psi	ASTM D-790
Izod Impact Notched .125" at 73°	1.7	ft. lb/in	ASTM D-256
Izod Impact Notched .125" at 32°	1.2	ft. lb/in	ASTM D-256
Drop Dart Impact .250" at 73°	53	ft. lbs	ASTM D-3763
Rockwell Hardness	115	R Scale	ASTM D-785
Optical			
Light Transmission	86	%	ASTM D-1003
Refractive Index	1.57	-	ASTM D-542
Haze	1.0	%	ASTM D-1003

Performance Comparison

Compare VIVAK Sheet's performance for interior fabricated and formed applications. It delivers an optimum balance of performance and economy.

Impact Strength Falling Dart @ 73°F

ASTM D-5420 @ .125" Acrylic Polycarbonate VIVAK® Sheet

10 in/lbs.	Failed	No break	No break
100 in/lbs.	Failed	No break	No break
300 in/lbs.	Failed	No break	No break
Heat Distortion @ 264 psi @ 66 psi	190°F	270°F	157°F
		280°F	164°F
Gamma Stability	Poor	Fair	Excellent
Chemical Resistance	Poor	Fair	Good

Material Availability

Materials	Gauge Range	Colors	Patterns	Sizes
VIVAK® Sheet	.020"-.375"	Standard: • Clear Custom: • Tints • Opaques	Standard: • Polished 2 Sides	Standard: • 48" x 96" • 60" x 96" Custom: • Available

Application Limitations

VIVAK Sheet, like any thermoplastic, has its performance limitations under specific conditions and in particular environments. When selecting a product, the environment and the conditions under which the product is to be used should be considered by the user.

For Example:

- VIVAK Sheet's heat resistance of 164°F precludes its use in heat generating applications when typical temperatures exceed 164°F.
- While it is a common choice for interior signage, its limited UV resistance eliminates it as a potential choice for long-term outdoor applications. For exterior use, ask for information on VIVAK Sheet UV.
- VIVAK Sheet's good chemical resistance makes it ideally suited for harsh industrial environments. However, this chemical resistance may mean longer fixturing time when using solvent based adhesives.

Technical Assistance

Contact the Sheffield Technical Services Group on questions regarding specific applications or material recommendations.

**For Additional Information
Please Contact...**

**Sheffield Plastics Inc.
Customer Service Department
Phone: 800-254-1707
FAX: 800-457-3553
www.sheffieldplastics.com**

Sheffield will not be responsible for the use of this information relative to actual application. Users must make their own determination of its suitability for their specific use. No warranty is made for the fitness of any product, and nothing herein waives any of the seller's condition of sales.

Sheffield Plastics Inc.

A  Bayer MaterialScience Company

119 Salisbury Road
Sheffield, MA 01257
800-254-1707

Fax: 800-457-3553

www.sheffieldplastics.com

E-mail: info@sheffieldplastics.com

