

www.PalramAmericas.com

800-999-9459

9735 Commerce Circle • Kutztown, PA 19530



2220 MCKINLEY AVENUE, NATIONAL CITY, CA 91950
 619/477-4855 FAX 477-4874
 www.sdplastics.com



Distributed by:

Palram warrants that WallTuf panels will be free from defects in material or workmanship for a period of one year from date of purchase. Palram will, at its option, replace materials or refund purchase price to original purchaser for materials found to be defective, provided that such products have been installed in accordance with Palram's printed installation instructions. This warranty applies to reimbursement and specifically excludes payment for labor or costs of any other kind relating to the original or replacement installation. Palram shall not be liable for incidental or consequential damages. This warranty gives you specific legal rights, and you may also have other rights that vary from state to state.

Warranty

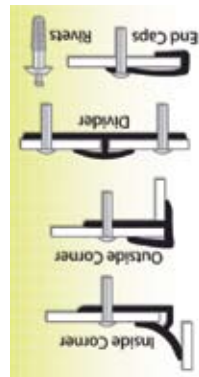

A Full Assortment of Accessory Moldings in Matching Colors
 Use matching accessory moldings to trim out panels and help achieve a water resistant finished wall. Place a small amount of silicone sealant in the channels of the moldings, and place bead of sealant along panel edges where moldings are not used.

Properties	ASTM Test Method	Typical Value
Water absorption	D-570	0.06%
Flame spread	E-84	105
Smoke developed	E-84	435
Gardner impact	D-3029	5.0 in. lb.
Shore hardness	D-2240	51
Coefficient of exp.	D-696	3.5 x 10 ⁻⁵ in./in./°F
Tensile strength	D-638	1190 PSI
Heat deflection	D-648	135°F
Tensile modulus	D-638	78 x 10 ³ PSI
Flexural modulus	D-790	78,240

- Product Specifications**
- Stock size: 4' x 8'; 4' x 10' is available as a special order.
 - Thickness: .090"
 - Standard Color: Bright White. Almond is available as a special order item, minimum quantities apply.
 - Packaging: 50 pieces per pallet
 - Material: Minimum 70% recycled plastic content
 - USDA: WallTuf panels comply with USDA guidelines for incidental food contact.

The waterproof panel that cleans up easily, absorbs scratches and is great for many applications for both home and industry



WallTuf

Waterproof Wall & Ceiling Liner Panels

Waterproof Wall & Ceiling Liner Panels



About WallTuf Panels

WallTuf wall and ceiling liner panels are ideally suited for both industrial and commercial interior applications. WallTuf panels are waterproof, light weight, have an attractive beaded texture, absorb scratches and clean up very easily, making them a great choice for areas that are moist, wet or damp, and need to clean up quickly and easily. To install as a wall panel, simply apply over drywall, no need to tape, mud, or sand. WallTuf can be cut to fit into lay-in ceiling grids. You will never see unsightly water stains again when using WallTuf as a ceiling panel. WallTuf panels are applied over drywall/sheetrock/gypsum wallboard, cinder block/concrete wall, by applying a continuous bead of an approved adhesive on backside of panel along edges and across.

The WallTuf installation process represents a net savings in time, and the enduring properties of the panel insure a long life and easy maintenance in commercial and industrial applications.

WallTuf Panels are Versatile...

- Designed for a wide variety of residential, commercial, industrial, and agricultural applications
- Waterproof material is excellent for use around pools
- Meets USDA guidelines for incidental food contact; ideal for restaurants and food processing applications
- Safe for animals; excellent for farm use, pet stores, etc.
- Attractive surface texture and two neutral colors blend well with any decor
- Easy to install, easy to clean, and easy to maintain



WallTuf Panels are Economical...

- Made primarily from recycled plastic... more cost effective than fiberglass filled panels.
- Resistance to stains, water & chemicals, plus easy cleaning, keeps WallTuf looking great for years to come
- Lower initial cost plus long-lasting performance add up to superior value!

WallTuf Panels are Tuf...

- Impact resistant
- Fiberglass-free formulation is resistant to chemicals
- Won't support the growth of mold or mildew
- Extremely resistant to stains
- Color goes all the way through the panel, so scratches don't show
- Panels can be rolled for shipment

Applications

WallTuf is mostly used in commercial and industrial settings that have a lot of moisture or require quick and easy cleanup.

Field applications include:

- Restaurant kitchens
- Gyms
- Showers
- Food processing plants
- Laundromats
- Locker rooms
- Commercial rest rooms
- Pools

FEATURES

- 100% Waterproof
- Fiberglass free
- Does not support mold
- Chemically inert
- UV resistant
- Color goes all the way through
- Heavy cracked-ice texture
- Class C flame spread rating
- Made from 100% recycled resins
- USDA/CFIA approved
- Easy installation

BENEFITS

- Non-absorbent: no swelling, rotting, or water discoloration
- No irritating, harmful fiberglass dust
- Hygienic: does not contribute to "sick"-building syndrome
- Not affected by acids, harsh chemical solvents or petroleum products
- For interior use, but will not yellow from fluorescent light or reflected sunlight
- Scratches don't show makes for extended product life
- Resists marring: good for high traffic areas
- Passes most interior building codes
- Contributes to Green Building: scrap can be recycled as grade #7
- Use in federally inspected food processing plants
- Can be scored with utility knife and snapped



*Almond is available as a special order only, minimum quantities apply.

Installation Guide

PRODUCT DESCRIPTION

Fiberglass-free WALLTUF™ panels are waterproof, stain & chemical resistant. WALLTUF complies with ASTM E-84 Class III, USDA, California's "Proposition 65" and the Canadian Food Inspection Agency (CFIA) requirements.

WALLTUF is the same material all the way through. The front side is embossed to enhance durability. The smooth back side is treated to accept waterbased adhesives. WALLTUF panels are designed to install with trowel grade latex adhesive over structurally sound solid interior walls, such as drywall or plywood. When installed with caulked moldings, WALLTUF panels form a moisture resistant, sanitary, low maintenance wall surface.

GENERAL INSTRUCTIONS

The following general instructions are for installing WALLTUF panels. This guide will help you select the other materials necessary for a successful installation. Always follow all adhesive, sealant and fastener manufacturer's instructions carefully.

STORAGE AND CONDITIONING

Panels must be stored flat on a smooth, dry surface. Before installation, allow panels to come to room temperature. Install panels at the temperature typical for the area after construction is finished.

ALLOWING FOR MOVEMENT

WALLTUF panels expand and contract with temperature changes. Space panels as shown. Do not use in structures subjected to extreme temperature changes, such as RV, Boat, and trailer interiors.

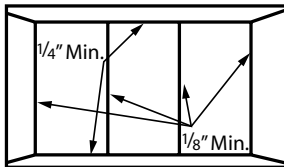
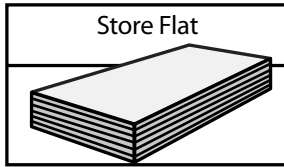

IMPORTANT! LEAVE A MINIMUM OF 1/8" BETWEEN AND 1/4" AT THE TOP AND BOTTOM OF EACH PANEL.

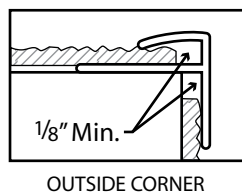
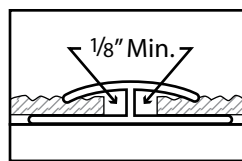
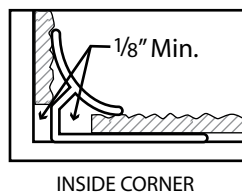
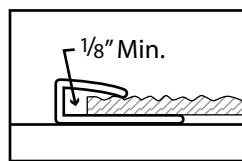

CUTTING & FITTING MOULDINGS

PVC mouldings are available for WALLTUF to facilitate installation. Mouldings can be cut with razor knife, fine toothed saw or metal shears. Do not fit panels too tightly in mouldings. Allow at least 1/8" in all channels for panel expansion after installation is completed. For a watertight installation, a continuous bead of sealant must be run in all molding channels and mating flanges. Mouldings should surround all edges of every panel. Excess sealant "squeeze out" can be cleaned off while fresh.

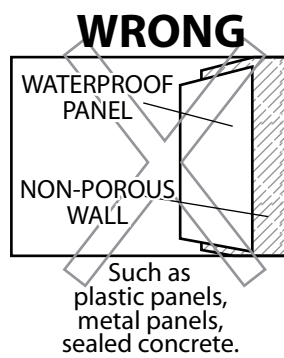
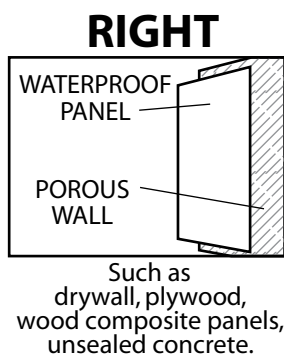

SURFACE PREPARATION & LAYOUT

Insure that walls are flat, clean, dry, and solid. Remove or sand through all waterproof surfaces. Remove all bumps, loose plaster or paint and dust. Fill all low spots and voids. Concrete block walls may require a leveling coat. Plan where the panel edges will meet, avoiding placement directly over drywall or plywood joints. Decide where to install the first panel and the best direction to work.

CUTTING & FITTING PANELS

Unlike other panels, WALLTUF panels contain no fiberglass or other irritants. They can be scored and snapped similar to drywall and cut with sheet metal shears. If sawing, use a fine toothed blade. Cut-outs such as for switches should be drilled at the corners to distribute stress. Test the panel fit by placing it in position without adhesive. Be careful to leave appropriate gap at panel edges. Do not fit panels too tightly in mouldings.

PANEL ADHESIVES

WALLTUF panels should be installed with a quality trowel grade non-flammable or latex based panel or construction adhesive listed in the chart on the reverse side. NOTE: The water-borne family of adhesives, including latex and non-flammable based formulas, will not bond two impervious surfaces to each other. Because WALLTUF panels are impervious to moisture, the wall being covered must be porous enough to allow for adhesive drying. Wall finishes that are moisture proof must be removed or otherwise prepared to insure that there is adequate adhesive curing. **Always follow adhesive manufacturer's directions completely.**

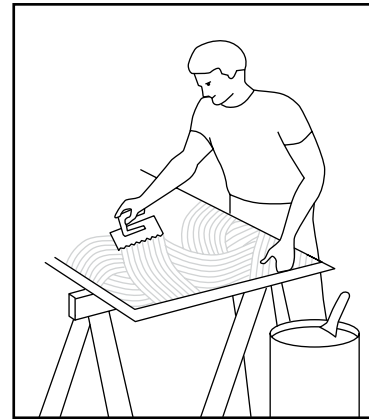
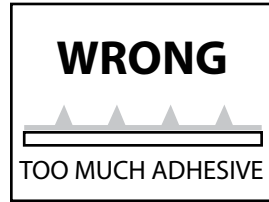
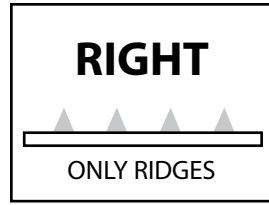

APPLYING ADHESIVE

Spread adhesive **over the entire back** of the panel following manufacturer's directions for trowel notch size and working temperature. Press spreader so that teeth touch panel. Leave only ridges of adhesive on the panel. Be sure to spread the adhesive on the panel, not the wall.

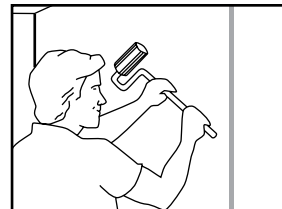

APPLYING THE PANEL

Position the panel and press against the wall. Take care to insure that the panels are not fitted too tightly. Use a laminate roller over the entire surface of the panels to ensure that there is even and complete adhesive contact with the wall at all points. Remove fresh adhesive and/or caulk.

MECHANICAL FASTENERS

Mechanical fasteners such as nylon drive rivets may be used in addition to adhesive. Install mechanical fasteners starting from the center of panel. Work systematically outwards, securing the perimeter last. Arrange fasteners on 16" centers with outer fasteners placed about 1" from panel edges. At panel seams, fasteners should be staggered to insure a flat seam.

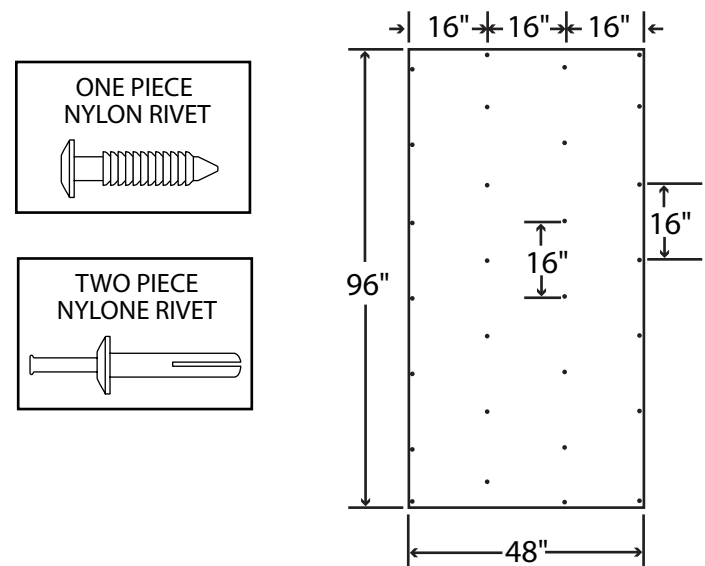

RECOMMENDED ADHESIVES

Tested & Rated by Manufacturer

Non-Flammable Adhesives	Mfg. Phone #	Rating (0-4)
Henry #444 FRP Panel Adhesive	800-232-7832	4.0
Liquid Nails FRP #310 Latex FRP Adhesive	800-634-0015	3.5
Franklin Titebond Fast Grab FRP	800-877-4583	2.0
OSI Sealants, Inc. Pro Series FRP-555	800-321-3578	2.0
PL Latex FRP	800-321-0253	2.0
TACC / Miracle FRP Adhesive	800-503-6991	1.5

NOT RECOMMENDED / NOT COMPATIBLE

All Solvent based and all tube style adhesives
DAP Durabond FRP Panel Adhesive
Foster #97-37 by H.B. Fuller

CLEANING AND MAINTENANCE

After installation panels may be cleaned with non-abrasive all purpose cleaners or soaps. For difficult stains such as felt marker or graphite, use Mineral Spirits or Acetone sparingly. Labels can be soaked off with penetrating oil such as WD-40.

THIS TECHNICAL BULLETIN IS FOR THE APPLICATION OF WALLTUF NRP BRAND WALL PANELS UNDER NORMAL CONDITIONS OF INSTALLATION. THE RECOMMENDATIONS PROVIDED IN THE BULLETIN REPRESENT OUR BEST JUDGMENT BASED ON OUR EXPERIENCE WITH NORMAL APPLICATIONS. INFORMATION HEREIN IS OFFERED WITHOUT CHARGE OR OBLIGATION, AND IS ACCEPTED AT RECIPIENT'S SOLE RISK. BECAUSE CONDITIONS OF USE MAY VARY AND ARE BEYOND OUR KNOWLEDGE AND CONTROL, THE MANUFACTURER MAKES NO REPRESENTATION ABOUT, AND IS NOT RESPONSIBLE OR LIABLE FOR THE ACCURACY OR RELIABILITY OF DATA, NOR FOR TOXICOLOGICAL EFFECT OR INDUSTRIAL HYGIENE REQUIREMENTS ASSOCIATED WITH PARTICULAR USES OF ANY PRODUCT OR PROCESS DESCRIBE HEREIN. THE MANUFACTURER REQUESTS THAT CUSTOMERS INSPECT AND TEST OUR PRODUCTS BEFORE USE AND SATISFY THEMSELVES AS TO CONTENTS AND SUITABILITY.